



## DRIVEWAY AND ROAD RESERVE RESTORATION WORKS

# SPECIFICATION

VERSION 1

**PENRITH**  
CITY COUNCIL

[penrithcity.nsw.gov.au](http://penrithcity.nsw.gov.au)

# Table of Contents

<b>1</b>	<b>DOCUMENT</b>	<b>5</b>
1.1	Preface	5
1.2	Revision Register	5
<b>2</b>	<b>GENERAL</b>	<b>6</b>
2.1	What is a Road Reserve	6
2.2	Works in the Road Reserve	6
2.3	Public Safety	6
2.4	Environment	6
2.4.1	Sediment Control	6
2.4.2	Council Trees	6
2.4.3	Landscaping	6
<b>3</b>	<b>DRIVEWAYS</b>	<b>7</b>
3.1	Permits, Inspections & Approval	7
3.1.1	Council Permits, Inspections & Approval	7
3.1.2	Driveways on State Roads	7
3.2	Standard Requirements	7
3.2.1	Subgrade	7
3.2.2	Base	7
3.2.3	Gradients	7
3.2.4	Crossfall	8
3.2.5	Driveway Width	8
3.2.6	Concrete Strength	8
3.2.7	Concrete Colour and Type	8
3.2.8	Concrete Joints	8
3.2.9	Driveway Edges	8
3.2.10	Driveways Near Intersections	8
3.2.11	Laybacks	8
3.2.12	Redundant Laybacks	9
3.2.13	Kerb & Gutter and Layback Modifications	9
3.2.14	Slip Resistance	9
3.2.15	Surface Finish	9
3.2.16	Footpath Connections	9
3.2.17	Existing Footpaths In Driveway Alignment	9
3.2.18	Additional Driveways	9
3.2.19	Private Stormwater Outlets	9
3.2.20	Driveway Reconstruction and Extensions	9
3.2.21	Driveway Completion	10

<b>3.3</b>	<b>Clearance Requirements for Utility Assets.....</b>	<b>10</b>
3.3.1	General.....	10
3.3.2	Telstra / NBN Pits.....	10
3.3.3	Sydney Water.....	10
3.3.4	Power Poles and Light Poles.....	10
3.3.5	Electrical Pillars.....	10
3.3.6	Council Stormwater Pits.....	11
<b>3.4</b>	<b>DCP Driveway Restrictions.....</b>	<b>11</b>
3.4.1	Caddens.....	11
3.4.2	Glenmore Park Stage 2.....	11
3.4.3	Jordan Springs & Jordan Springs East.....	11
<b>3.6</b>	<b>Residential Driveways.....</b>	<b>12</b>
3.6.1	Driveways For Single Dwelling and Dual Occupancy Residential.....	12
3.6.2	Driveways for Medium Density Residential and Townhouses.....	12
3.6.3	Heavy Duty Paved Residential Driveways.....	13
3.6.4	Rolled Kerb Modification Into A Layback.....	13
<b>3.7</b>	<b>Industrial and Commercial Driveways.....</b>	<b>14</b>
3.7.1	Driveways for Light Industrial / Commercial.....	14
3.7.2	Driveways for Heavy Industrial / Commercial.....	14
<b>3.9</b>	<b>Rural Driveways.....</b>	<b>15</b>
3.9.1	General Requirements.....	15
3.9.2	Rural Driveways With Dish Drain Crossings.....	16
3.9.4	Rural Driveways With Pipe Crossings.....	17
<b>4</b>	<b>ROAD RESERVE RESTORATION WORKS.....</b>	<b>18</b>
<b>4.1</b>	<b>Council Permits, Inspections &amp; Approvals.....</b>	<b>18</b>
4.1.1	Council Permits, Inspections & Approval.....	18
4.1.2	Public Domain Manuals.....	18
4.1.3	Paver Materials.....	18
<b>4.2</b>	<b>Concrete Asset Restoration.....</b>	<b>18</b>
4.2.1	General Requirements.....	18
<b>4.3</b>	<b>Pedestrian Access.....</b>	<b>18</b>
4.3.1	Footpaths & Shared Cycleways.....	18
4.3.2	Kerb Ramps / Pram Ramps.....	19
<b>4.4</b>	<b>Kerb &amp; Gutters.....</b>	<b>19</b>
4.4.1	Kerb & Gutter Reconstruction.....	19
4.4.2	Private Stormwater Outlets.....	21
4.4.3	RHS Stormwater Outlets.....	21
4.4.4	Redundant Stormwater Outlets.....	21
<b>4.5</b>	<b>Road Pavement.....</b>	<b>21</b>
4.5.1	General Restoration.....	21

4.5.2	Service Utility Trenching Road Pavement Restoration .....	21
4.5.3	Service Utility Trenching on Nature Strip .....	22
<b>4.6</b>	<b>Decorative Thresholds .....</b>	<b>22</b>
<b>4.7</b>	<b>Nature Strip .....</b>	<b>22</b>
<b>5</b>	<b>GLOSSARY OF TERMS.....</b>	<b>23</b>

# 1 DOCUMENT

## 1.1 Preface

This Specification is for the construction of new driveways and the restoration of Council assets in the road reserve for the Penrith Local Government Area, and has been prepared to provide building developers and constructors with the complying Council requirements which has been sourced from Council's latest Engineering Construction Specification for Civil Works.

It is the user's sole responsibility to ensure that the copy of the Specification available to them is the current version as in use by the Council.

Penrith City Council accepts no liability whatsoever in relation to the use of this Specification by any party, and Council excludes any liability which arises in any manner by the use of this Specification.

## 1.2 Revision Register

<b>Version</b>	<b>Date</b>	<b>Clause</b>	<b>Description of Revision</b>	<b>Reviewer</b>
1	January 2022	All	Initial draft, review and first revision release	City Assets – ODP, AR, HD, NK, SJ, DM

## 2 GENERAL

### 2.1 What is a Road Reserve

The road reserve is the Council owned land on a length from one property boundary to the opposite property boundary on a road. On State Roads, Council only maintains the road verge from the back of gutter to the property boundary.

A road reserve can include nature strips, driveways, footpaths, kerb and gutters, and the road pavement.



### 2.2 Works in the Road Reserve

- All works in the road reserve shall require [Council approval](#) under Section 138 of the Roads Act 1993.
- Accredited contractors shall conduct the works with appropriate and current insurances in place.

### 2.3 Public Safety

- Appropriate barriers for the protection of the public must be erected and maintained at any work site on Council owned or managed property.

### 2.4 Environment

#### 2.4.1 Sediment Control

- Soil erosion and sedimentation control measures shall be maintained during the construction until the disturbed areas are restored and stabilized.

#### 2.4.2 Council Trees

- All Council street trees, vegetation, and root systems shall be protected as required from the edge of any construction.
- No trees shall be removed without Council permission.

#### 2.4.3 Landscaping

- All nature strip areas are to be turfed for the full width except for the concrete footpath from the back of kerb to the property boundary.
- Council approval from City Assets shall be obtained where private landscaping extends to the road reserve.

## 3 DRIVEWAYS

Driveways and footpath paving related to the construction of a Driveway may only be carried out by property owners, or accredited licensed contractors subject to the conditions of this specification.

### 3.1 Permits, Inspections & Approval

#### 3.1.1 Council Permits, Inspections & Approval

Any works in the road reserve will require Council approval under Section 138 of the Roads Act 1993.

All new proposed driveway construction and reconstruction of existing driveways shall lodge a [Driveway Application](#) with Penrith Council. An inspection shall be booked in to assess pre-pour conditions. After you apply:

- 1) You will receive an automated response via email with the application number. Please use this application number as a reference in any future communications with Council regarding the driveway.
- 2) When the driveway is ready to pour, **you are required to book an initial inspection** by contacting Council's Asset Management Department via phone on (02) 4732 7777 at the latest **before 12PM one business day prior** to the requested inspection date. Please allow sufficient time between the inspection and the pour for any required rectifications.
- 3) You will then receive the results of the Initial Inspection via email:
  - a. PASS – you are permitted to pour concrete following any additional conditions in the report.
  - b. FAIL – you are not permitted to pour concrete until all issues have been rectified and another initial inspection booked.
- 4) Council will automatically book in a final inspection 2 weeks after the initial inspection has been approved.
- 5) You will then receive the results of the final inspection via email:
  - a. PASS – the driveway construction is approved by Council. Other road reserve conditions may be commented on as part of the overall development.
  - b. FAIL – the conditions in the initial inspection were not followed or the final driveway does not comply and may need to be reconstructed and an initial inspection required to be booked again.

#### 3.1.2 Driveways on State Roads

- Transport for NSW (TfNSW) is responsible for approving works from the back of the layback out onto the state road as it is their asset.
- It is recommended to construct the layback first prior to the driveway to ascertain drainage levels on the State Road.
- Generally, TfNSW approval must be provided to Council prior to any driveway inspections by Council.

### 3.2 Standard Requirements

#### 3.2.1 Subgrade

- Driveway subgrade surfaces must be completely free of depressions, potholes, and loose materials in readiness for construction. Subgrade must be compacted to an adequate standard.

#### 3.2.2 Base

- The base under the concrete Driveway is to comprise of sand or similar fine-grained material and compacted to a depth of 30mm.

#### 3.2.3 Gradients

- All driveways (including rural) are to have a minimum grade of 4% up to a maximum grade of 12.5% (1:8) over the first 3 metres from the layback.
- In some cases, due to the existing shape of the land this may not be possible, a transition curve from the property boundary line will be required.
- Special dispensations shall be made for driveways in very flat areas where minimum grades cannot be met.

### 3.2.4 Crossfall

- Driveways are to have a minimum 2% (1:50) to 5% (1:20) maximum crossfall.
- Dispensations are to be made for crossovers in hilly areas where the slope of the road/verge is greater than the required.

### 3.2.5 Driveway Width

- All new and reconstructed driveways shall be minimum 3m wide. Please refer to relevant section.
- The minimum width is in accordance with AS2890.1:2004 for residential driveways and AS2890.2:2002 for commercial/industrial driveways.

### 3.2.6 Concrete Strength

- Minimum 25 MPa concrete strength for light vehicle residential driveways that meets AS3600.
- Minimum 32 MPa concrete strength for heavy vehicle / commercial / industrial driveways that meets AS3600.

### 3.2.7 Concrete Colour and Type

- Types of concrete allowed over the road reserve are plain grey, coloured, and stencil concrete (pavers).
- Plain grey concrete only for the section of driveway over the road reserve in new subdivision areas such as Jordan Springs, Caddens, Waterside, Mulgoa Rise, Glenmore Park Stage 2, Claremont Meadows Stage 2, Werrington (Settler's Estate & Chapman St subdivision) etc.
- The use of stamped, exposed aggregate or pebblecrete concrete is NOT allowed on the section of driveway over the road reserve.

### 3.2.8 Concrete Joints

- Full depth sawcut joint at the property boundary.
- Full depth 10mm mastic expansion joint to be installed between the layback and driveway.
- Driveways that exceed 6m in either direction or 36m<sup>2</sup> in area must have a control sawcut joint perpendicular to the roadway.

### 3.2.9 Driveway Edges

- In compliance with minimum driveway width requirements, new driveways over the nature strip shall be:
  - Perpendicular (90 degrees) to the kerb; or
  - Have the sides equally angled outwards from the property boundary, but not inward; or
  - Parallel to the property boundary line.
- Driveway edges shall be in a straight line from the layback to the property boundary i.e. no stepping out.
- In some instances, due to the unique shape of the property lot, street trees/lights and/or the curvature of the road, the above requirements may not be met. Approval for these driveways shall be at the Inspection Officer's discretion.

### 3.2.10 Driveways Near Intersections

- Driveways shall be no closer than 6m to the kerb tangent point near street intersections or sharp 90 degree sweeping road bends.

### 3.2.11 Laybacks

- Laybacks shall be poured separately to the driveway. Connolly key joint method can be used.
- Edge of driveways must meet the layback at the bottom of wing.
- **A new layback must be provided, or the existing layback modified to suit the proposed driveway if the new driveway does not align with an existing layback.** Driveway to meet minimum width requirements.
- Laybacks shall be dowelled into the new driveway, and existing kerb and gutter.
- Sub-base shall be compacted 200mm thickness on top of compacted sub-grade.
- Any damage to adjacent pavement shall be restored 300mm from lip of gutter with hotmix asphalt and crack sealed.
- Layback wings shall be 700mm long from the edge of driveway.



### **3.2.12 Redundant Laybacks**

- Redundant laybacks shall be replaced with a permanent kerb & gutter. Any damage to adjacent pavement shall be restored 300mm from lip of gutter with hotmix asphalt and crack sealed.
- In cases where a new layback is required at a different location to the existing layback, approval will only be granted conditional on the unused layback being restored at the same time, unless both are to be formalized driveways upon completion of construction.

### **3.2.13 Kerb & Gutter and Layback Modifications**

- Kerb, gutter and/or layback shall be removed from construction joint to the next construction joint, and from lip line to the back of kerb.
- The new kerb, gutter and/or layback shall be dowelled into the existing kerb & gutter.
- Any damage to adjacent pavement shall be restored 300mm from lip of gutter with hotmix asphalt and crack sealed.

### **3.2.14 Slip Resistance**

- All driveways shall comply with slip resistance classification standards for pedestrian surface materials under AS/NZS 4586:2013 and AS/NZS 3661.2:1994. The finish surface must be sufficiently rough so as to ensure safety for pedestrian and other users.

### **3.2.15 Surface Finish**

- The finished surface must NOT be finished in a smooth steel float finish.
- The finished surface must NOT be coated with epoxy type 'paint' or sealant.

### **3.2.16 Footpath Connections**

- Private footpath connections (separate to driveways) are permitted to be constructed over the road reserve to connect with the Council footpath.
- Steel reinforcing mesh and 12mm dowels into the existing footpath shall be provided where required.
- Similar to driveways, the maintenance of private footpath connections remains under the responsibility of the private property owner.

### **3.2.17 Existing Footpaths In Driveway Alignment**

- It is recommended that the existing footpath be removed to allow the driveway to remain continuous from the property boundary line to the layback.
- Dummy joint sawcut to be provided across the driveway to indicate footpath alignment.

### **3.2.18 Additional Driveways**

- Additional driveways to existing properties shall be subject to Council's assessment. Construction of additional driveways is not allowed unless Council consent has been received via a DA process or City Assets review. Outside of this, a driveway application for an additional driveway does not constitute approval.

### **3.2.19 Private Stormwater Outlets**

- Private stormwater outlets shall not be situated within the layback and wings.
- Outlets on rolled kerb profiles shall not fall within the driveway alignment.
- Refer to Private Stormwater Outlet section for additional requirements.

### **3.2.20 Driveway Reconstruction and Extensions**

- Reconstruction and extending of existing driveways and the modification of infrastructure such as laybacks, kerb & gutters, and footpaths due to the driveway construction shall be compliant with this specification.
- Minimum 600mm extension.
- Layback to be reconstructed to suit new driveway width.
- Where the existing driveway meets the top of wing, the new driveway shall be to the bottom of wing.
- Where only one of the layback wings are reconstructed, the new wing length can match the other side.

- Where a layback extends to an adjacent property's driveway (in the case of parallel adjacent driveways), a wing will not be required in the middle. New layback to dowel into existing layback.
- Material to match the existing driveway but the use of stamped, exposed aggregate or pebblecrete concrete is NOT allowed.
- Driveway extensions shall be dowelled into the existing driveway where possible.

### 3.2.21 Driveway Completion

- Driveway construction formwork and debris shall be removed.
- Any excavated areas shall be backfilled, levelled to the top of the driveway slab, and made safe for pedestrians.
- Grassed turf to be reinstated on the disturbed nature strip. If the property is a new development, this can be done later upon final landscaping.
- Any restorations required noted in the initial inspection report shall be completed.
- Maintenance for any settlement or microcracking of the driveway that occurs after construction is the driveway owner's responsibility.

## 3.3 Clearance Requirements for Utility Assets

### 3.3.1 General

- Any damages to existing services and public utility assets due to the construction shall be restored at no cost to Council.
- Written approval must be obtained and provided to Council from Service Authorities should any utility services be required to be relocated, modified or remain in the driveway area.
- Special dispensations shall be made regarding driveway replacements in older established areas that may not meet the current minimum service clearance requirements.
- Where possible all options shall be explored to meet the minimum clearance requirements set out below such as repositioning of driveway alignment, moving the service etc.

### 3.3.2 Telstra / NBN Pits

- Minimum 300mm clearance generally from the edge of any proposed driveway to any Telstra or NBN assets.
- Telecommunication assets shall not be situated within the driveway or be less than 300mm clear of the driveway unless Telstra/NBN approval has been received and provided to Council prior to the initial inspection.
- The Network Integrity Group should be contacted on 1800 810 443 or via their website: <https://www.telstra.com.au/consumer-advice/digging-construction/relocating-network-assets> for any relocations or modifications to Telstra/NBN assets.

### 3.3.3 Sydney Water

- Any Sydney Water asset access points shall be serviceable and not be covered with any material such as concrete, nor shall any colouring (i.e. painting), or synthetic turf on the feature be carried out.
- For any Sydney Water assets located within the new driveway, approval shall be obtained via the [Sydney Water Tap In Portal](#) and provided to Council prior to the initial inspection.

### 3.3.4 Power Poles and Light Poles

- Residential driveways shall be minimum 1m clearance from the edge of driveway to any power pole or light pole.
- Industrial and commercial driveways shall be minimum 1.5m clearance from the edge of driveway to any power pole or light pole.

### 3.3.5 Electrical Pillars

- Minimum 300mm clearance from the edge of driveway to any green electrical pillars in residential areas.

### 3.3.6 Council Stormwater Pits

- Residential driveways shall be minimum 1m from the edge of Council's stormwater drainage pits.
- Industrial / commercial driveways shall be minimum 2m from the edge of Council's stormwater drainage pits.
- Where there is an existing kerb inlet pit within the proposed driveway alignment, this can be converted into a butterfly grate at no cost to Council subject to:
  - Applicants to speak to Council to discuss proposed works;
  - An additional kerb inlet pit being provided upstream to ensure sufficient inlet capacity is maintained; and
  - The additional kerb inlet pit lintel edge shall be at least 1m away from the driveway edge.

## 3.4 DCP Driveway Restrictions

Below are some common driveway restrictions (but not limited to) based on [Penrith City Council's Development Control Plans \(DCP\)](#) for current subdivision development areas in the LGA. It is the builder's responsibility to ascertain what development controls are in place for the proposed driveway.

### 3.4.1 Caddens

- Driveways are to be no wider than 4.5m and minimum 1.5m away from street trees
- Stencilcrete driveways are not permitted.
- Driveway section over the nature strip shall be in plain grey concrete only and must be perpendicular to the kerb line.

### 3.4.2 Glenmore Park Stage 2

- Driveway section over the nature strip shall be in plain grey concrete only and must be perpendicular to the kerb line.

### 3.4.3 Jordan Springs & Jordan Springs East

- Driveways shall be 3m wide for single garage and 5m wide for double garage.
- Driveway section over the nature strip shall be in plain grey concrete only and must be perpendicular to the kerb line.

### 3.6 Residential Driveways

Below is a general layout of a residential driveway construction.

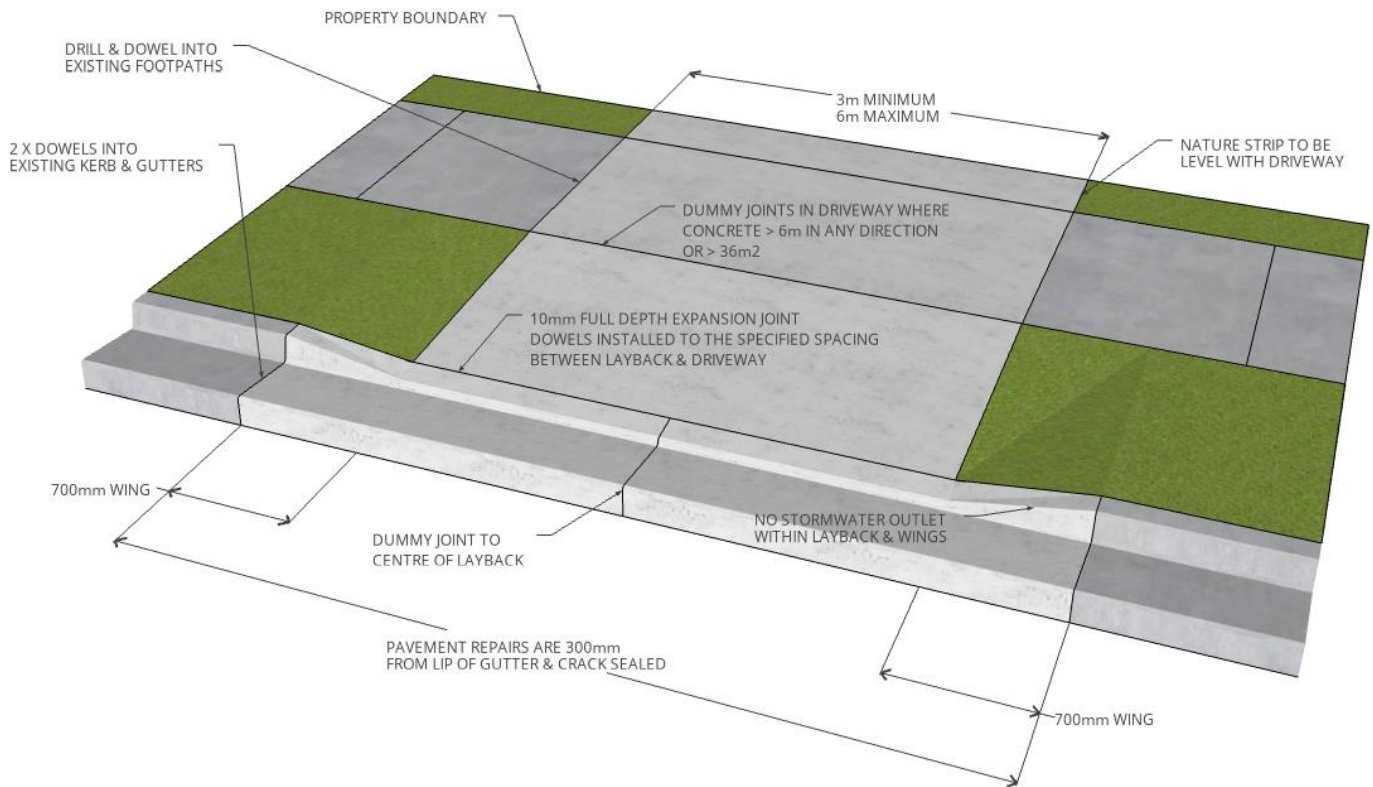

#### 3.6.1 Driveways For Single Dwelling and Dual Occupancy Residential

<b>Driveway Base</b>	<ul style="list-style-type: none"> <li>30mm thick compacted sand or other granular material on compacted subgrade</li> </ul>
<b>Concrete Thickness</b>	<ul style="list-style-type: none"> <li>100mm minimum</li> </ul>
<b>Driveway Width</b>	<ul style="list-style-type: none"> <li>3m minimum to 6m maximum (AS 2890.1:2004)</li> </ul>
<b>Concrete Strength</b>	<ul style="list-style-type: none"> <li>25MPa minimum</li> </ul>
<b>Reinforcing Bars</b>	<ul style="list-style-type: none"> <li>One layer of min. SL72 reinforcing steel mesh supported on chairs</li> </ul>
<b>Dowels</b>	<ul style="list-style-type: none"> <li>12mm galvanized dowels installed into the back of layback, adjoining footpaths, and existing gutters</li> </ul>
<b>Dowel Spacing</b>	<ul style="list-style-type: none"> <li>350mm from each side then installed at 900mm centres at layback</li> <li>2 x dowels to existing concrete gutters</li> </ul>
<b>Driveway Colour</b>	<ul style="list-style-type: none"> <li>Refer to Section 3.2.7</li> </ul>

#### 3.6.2 Driveways for Medium Density Residential and Townhouses

<b>Driveway Base</b>	<ul style="list-style-type: none"> <li>30mm thick compacted sand or other granular material on compacted subgrade</li> </ul>
<b>Concrete Thickness</b>	<ul style="list-style-type: none"> <li>150mm minimum</li> </ul>
<b>Driveway Width</b>	<ul style="list-style-type: none"> <li>3m minimum to 6m maximum (AS 2890.1:2004)</li> </ul>
<b>Concrete Strength</b>	<ul style="list-style-type: none"> <li>25MPa minimum</li> </ul>
<b>Reinforcing Bars</b>	<ul style="list-style-type: none"> <li>One layer of min. SL72 reinforcing steel mesh supported on chairs</li> </ul>
<b>Dowels</b>	<ul style="list-style-type: none"> <li>12mm galvanized dowels installed into the back of layback, adjoining footpaths, and existing gutters</li> </ul>
<b>Dowel Spacing</b>	<ul style="list-style-type: none"> <li>500mm from each side then installed at 900mm centres</li> <li>2 x dowels to existing concrete gutters</li> </ul>
<b>Driveway Colour</b>	<ul style="list-style-type: none"> <li>Refer to Section 3.2.7</li> </ul>

### 3.6.3 Heavy Duty Paved Residential Driveways

- Private property owners are responsible for the maintenance of pavers, keeping them true and level at all times.
- Pavers are not to form part of the footpath.

<b>Driveway Base</b>	<ul style="list-style-type: none"> <li>• 30mm thick compacted sand or other granular material on compacted subgrade</li> </ul>
<b>Concrete Thickness</b>	<ul style="list-style-type: none"> <li>• 100mm minimum</li> </ul>
<b>Driveway Width</b>	<ul style="list-style-type: none"> <li>• 3m minimum to 6m maximum (AS 2890.1:2004)</li> </ul>
<b>Concrete Strength</b>	<ul style="list-style-type: none"> <li>• 25MPa minimum</li> </ul>
<b>Reinforcing Bars</b>	<ul style="list-style-type: none"> <li>• One layer of min. SL72 reinforcing steel mesh wired supported on chairs</li> </ul>
<b>Dowels</b>	<ul style="list-style-type: none"> <li>• 12mm galvanized dowels installed into the back of layback and adjoining footpaths for residential dwellings</li> <li>• 20mm galvanized dowels installed into the back of layback and adjoining footpaths for townhouses</li> </ul>
<b>Dowel Spacing</b>	<ul style="list-style-type: none"> <li>• 350mm from each side then installed at 900mm centres for residential dwellings</li> <li>• 500mm from each side then installed at 900mm centres for townhouses</li> </ul>
<b>Paver Installation</b>	<ul style="list-style-type: none"> <li>• Pavers are to be laid in accordance with the manufacturer's specifications and shall be 60mm minimum thickness.</li> <li>• Pavers are to be placed, with a nominal gap between pavers and filled with fine sand or suitable replacement.</li> </ul>
<b>Edge Restraints</b>	<ul style="list-style-type: none"> <li>• Concrete edge restraints must be used to restrain the pavers and the sand.</li> </ul>

### 3.6.4 Rolled Kerb Modification Into A Layback

- This sub-section shall be used for the modification of an existing rolled kerb into a layback.
- Minimum 450mm wing transitions to rolled kerb. No stormwater outlets to be within wings and layback.
- Layback shall be shaped and graded to mitigate water retention.
- Layback shall be dowelled into driveway and existing rolled kerb.
- Dummy joint in centre of layback where applicable.
- 10mm full depth expansion joint between driveway and layback.
- The edge of driveway can be to top of wing. See example images below.

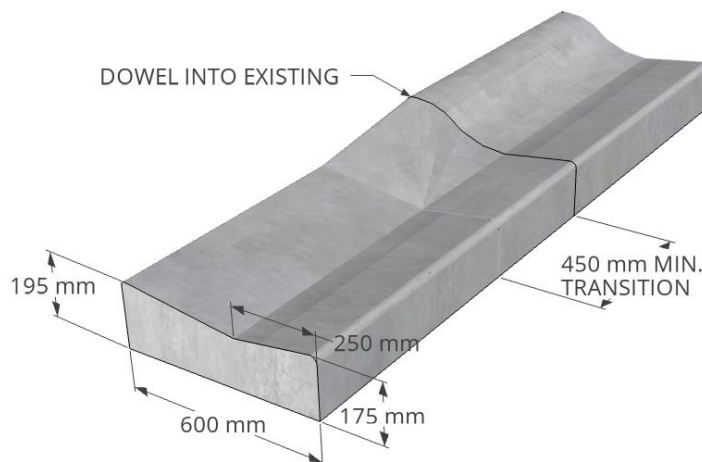

### 3.7 Industrial and Commercial Driveways

Below is a general layout of a commercial / industrial driveway construction.

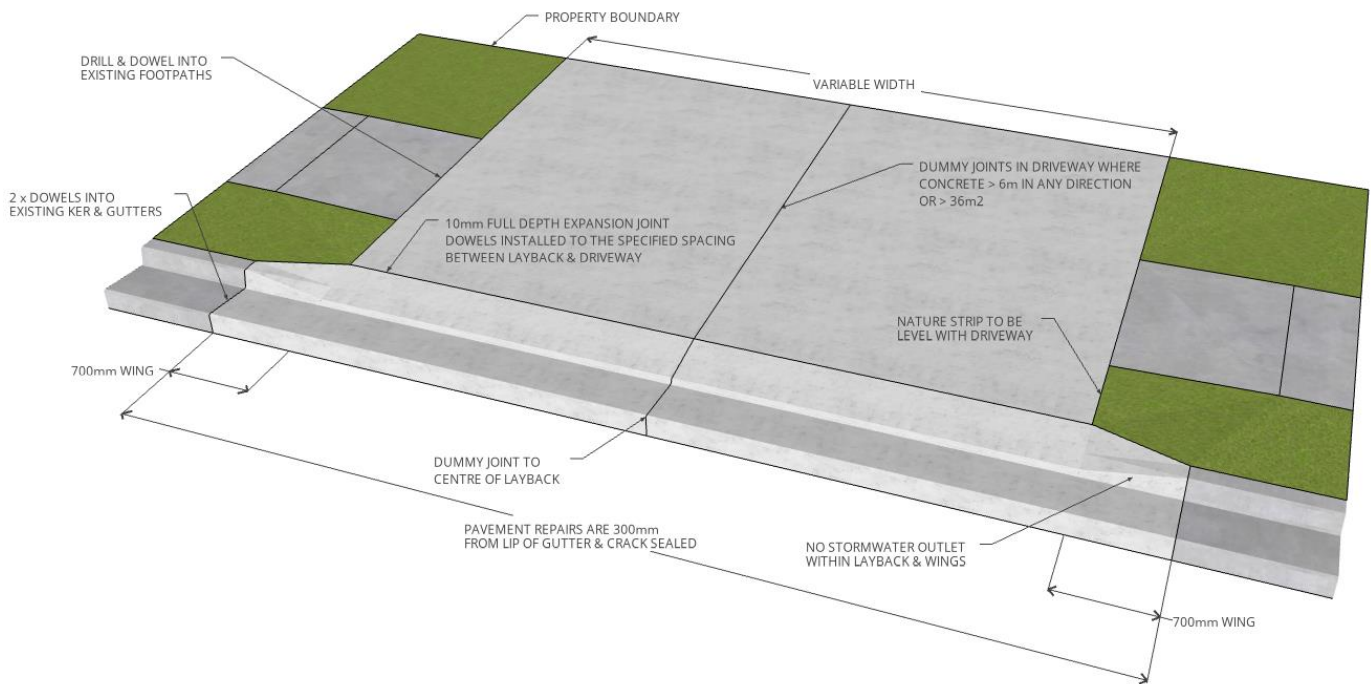

#### 3.7.1 Driveways for Light Industrial / Commercial

- Typical requirements to accommodate small to medium rigid vehicles (SRV & MRV)

<b>Driveway Base</b>	<ul style="list-style-type: none"> <li>• 30mm thick compacted sand or other granular material on compacted subgrade</li> </ul>
<b>Concrete Thickness</b>	<ul style="list-style-type: none"> <li>• 150mm minimum</li> </ul>
<b>Driveway Width</b>	<ul style="list-style-type: none"> <li>• Minimum width is 6m (AS 2890.2:2002) or as indicated in a DA</li> </ul>
<b>Concrete Strength</b>	<ul style="list-style-type: none"> <li>• 32MPa minimum</li> </ul>
<b>Reinforcing Bars</b>	<ul style="list-style-type: none"> <li>• One layer of min. SL82 reinforcing steel mesh supported on chairs</li> </ul>
<b>Dowels</b>	<ul style="list-style-type: none"> <li>• 12mm galvanized dowels installed into the back of layback, adjoining footpaths, and existing gutters</li> </ul>
<b>Dowel Spacing</b>	<ul style="list-style-type: none"> <li>• 500mm from each side then installed at 900mm centres</li> <li>• 2 x dowels to existing concrete gutter</li> </ul>
<b>Driveway Colour</b>	<ul style="list-style-type: none"> <li>• Plain grey concrete from the property boundary to the layback</li> </ul>

#### 3.7.2 Driveways for Heavy Industrial / Commercial

- Typical requirements to accommodate heavy rigid vehicles (HRV) and articulated vehicles (AV).

<b>Driveway Base</b>	<ul style="list-style-type: none"> <li>• 30mm thick compacted sand or other granular material on compacted subgrade</li> </ul>
<b>Concrete Thickness</b>	<ul style="list-style-type: none"> <li>• 225mm minimum</li> </ul>
<b>Driveway Width</b>	<ul style="list-style-type: none"> <li>• Minimum width is 15.5m (AS 2890.2:2002) or as indicated in a DA</li> </ul>
<b>Concrete Strength</b>	<ul style="list-style-type: none"> <li>• 32MPa minimum</li> </ul>
<b>Reinforcing Bars</b>	<ul style="list-style-type: none"> <li>• Two layers of min. SL82 reinforcing steel mesh supported on chairs</li> </ul>
<b>Dowels</b>	<ul style="list-style-type: none"> <li>• 20mm galvanized dowels installed into the back of layback, adjoining footpaths, and existing gutters</li> </ul>
<b>Dowel Spacing</b>	<ul style="list-style-type: none"> <li>• 500mm from each side then installed at 900mm centres</li> <li>• 2 x dowels to existing concrete gutter</li> </ul>
<b>Driveway Colour</b>	<ul style="list-style-type: none"> <li>• Plain grey concrete from the property boundary to the layback</li> </ul>

## 3.9 Rural Driveways

### 3.9.1 General Requirements

- Due to the variances involved with driveways rural areas – with differences in road reserves types, general grade of the land and table drain locations, a site inspection by Council Asset Officers may be required before any works commence to ascertain levels, designs etc.
- Council Standard rural driveway pavement designs are intended for typical residential use only. If the intended frequency and size for vehicles are greater than allowed, the pavement design shall reflect this increased loading.
- Refer to Section 3.2 for other applicable standard requirements.

<b>GENERAL</b>	
<b>Driveway Width at Edge of Road</b>	<ul style="list-style-type: none"> <li>• 4m minimum on local roads</li> <li>• 6m minimum on state roads</li> </ul>
<b>Guideposts</b>	<ul style="list-style-type: none"> <li>• White guidepost fitted with retroreflectors to be installed on approach side</li> </ul>
<b>Drainage</b>	<ul style="list-style-type: none"> <li>• Driveways must be constructed with a concrete dish drain or pipe crossing to allow adequate overland drainage.</li> <li>• Where the surrounding area is almost flat (less than 4% grade) in either direction, the driveway can be constructed in either concrete and/or asphalt without the need for a dish drain and the final driveway surface level shall be flush with the nature strip (not raised).</li> </ul>
<b>CONCRETE SECTION DRIVEWAY</b>	
<b>Base</b>	<ul style="list-style-type: none"> <li>• 30mm thick compacted sand or other granular material on compacted subgrade</li> </ul>
<b>Concrete Thickness</b>	<ul style="list-style-type: none"> <li>• 150mm minimum</li> </ul>
<b>Concrete Strength</b>	<ul style="list-style-type: none"> <li>• 25MPa minimum</li> </ul>
<b>Reinforcing Bars</b>	<ul style="list-style-type: none"> <li>• Driveway – single layer min. SL72 reinforcing steel mesh supported on chairs</li> <li>• Dish drain – double layer min. SL72 reinforcing steel mesh supported on chairs</li> </ul>
<b>Concrete Cover</b>	<ul style="list-style-type: none"> <li>• 50mm top cover</li> </ul>
<b>Expansion &amp; Dummy Joints</b>	<ul style="list-style-type: none"> <li>• Full depth dowelled expansion joints every 6m or area &gt;36m<sup>2</sup></li> <li>• Dummy joints every 2m</li> </ul>
<b>ASPHALT SECTION DRIVEWAY</b>	
<b>Subgrade</b>	<ul style="list-style-type: none"> <li>• 150mm minimum thickness of compacted DGB20 or similar</li> <li>• Compact using a 10 tonne steel wheeled roller or equivalent methodology</li> </ul>
<b>Asphalt Seal</b>	<ul style="list-style-type: none"> <li>• 25mm thick AC10 or AC14 wearing course or 2 coat seal</li> </ul>

### 3.9.2 Rural Driveways With Dish Drain Crossings

- Dish drains shall have double layer min. SL72 reinforcing steel mesh supported on chairs.
- Drainage levels shall allow water to flow through the dish drain.

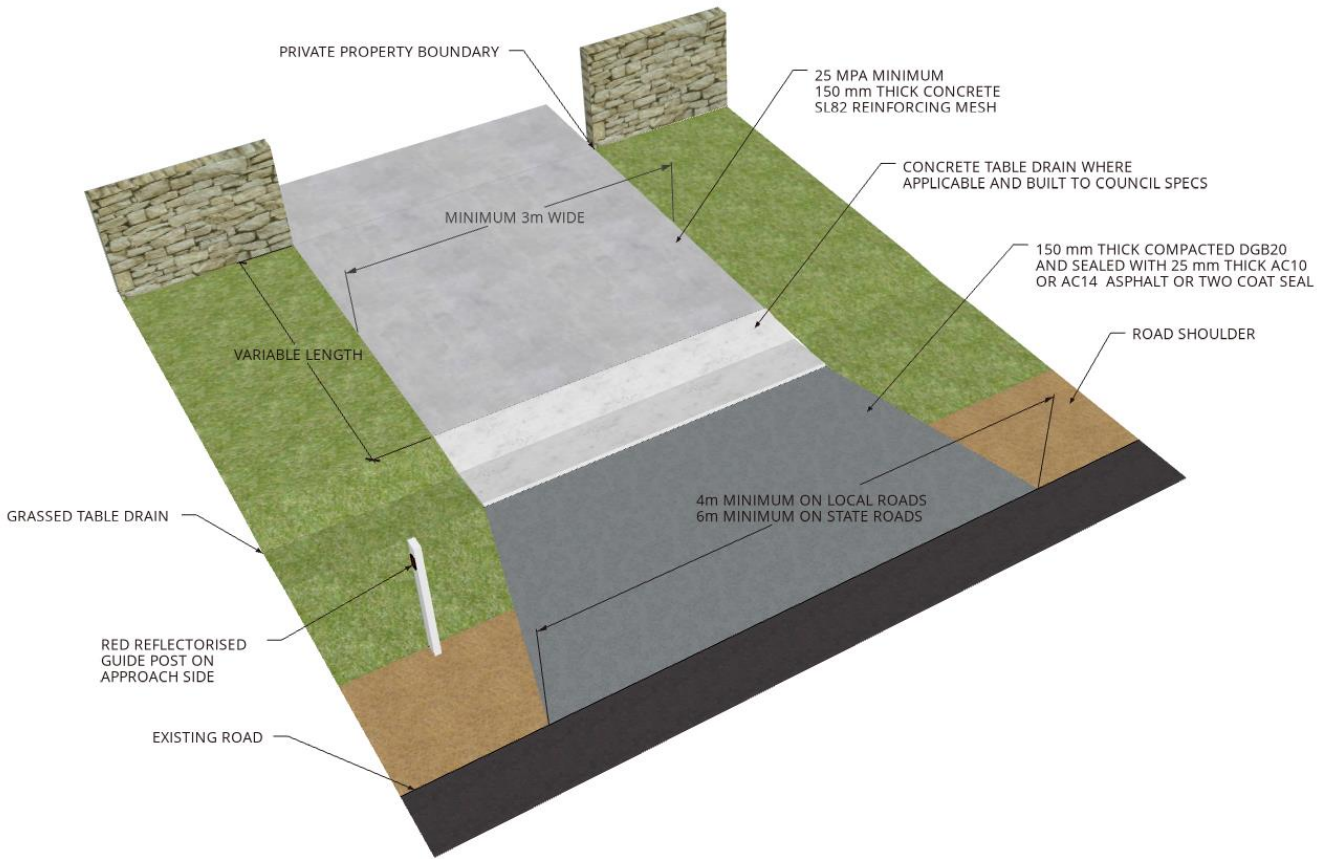



### 3.9.4 Rural Driveways With Pipe Crossings

- Minimum DN300 diameter concrete pipe capacity or equivalent configuration (e.g. 2 x DN225). Cross-sectional area to be greater than 0.28m<sup>2</sup>. PVC pipes not allowed.
- Larger pipe diameters may be required for channels with greater expected water volumes.
- Minimum 2 x standard 2.4m pipe lengths and headwalls to both sides of the crossing shall be installed on a sand/cement base.
- Minimum 100mm pipe cover of compacted sand or DGB20 or similar material.
- Drainage levels shall allow water to flow through the pipeline.

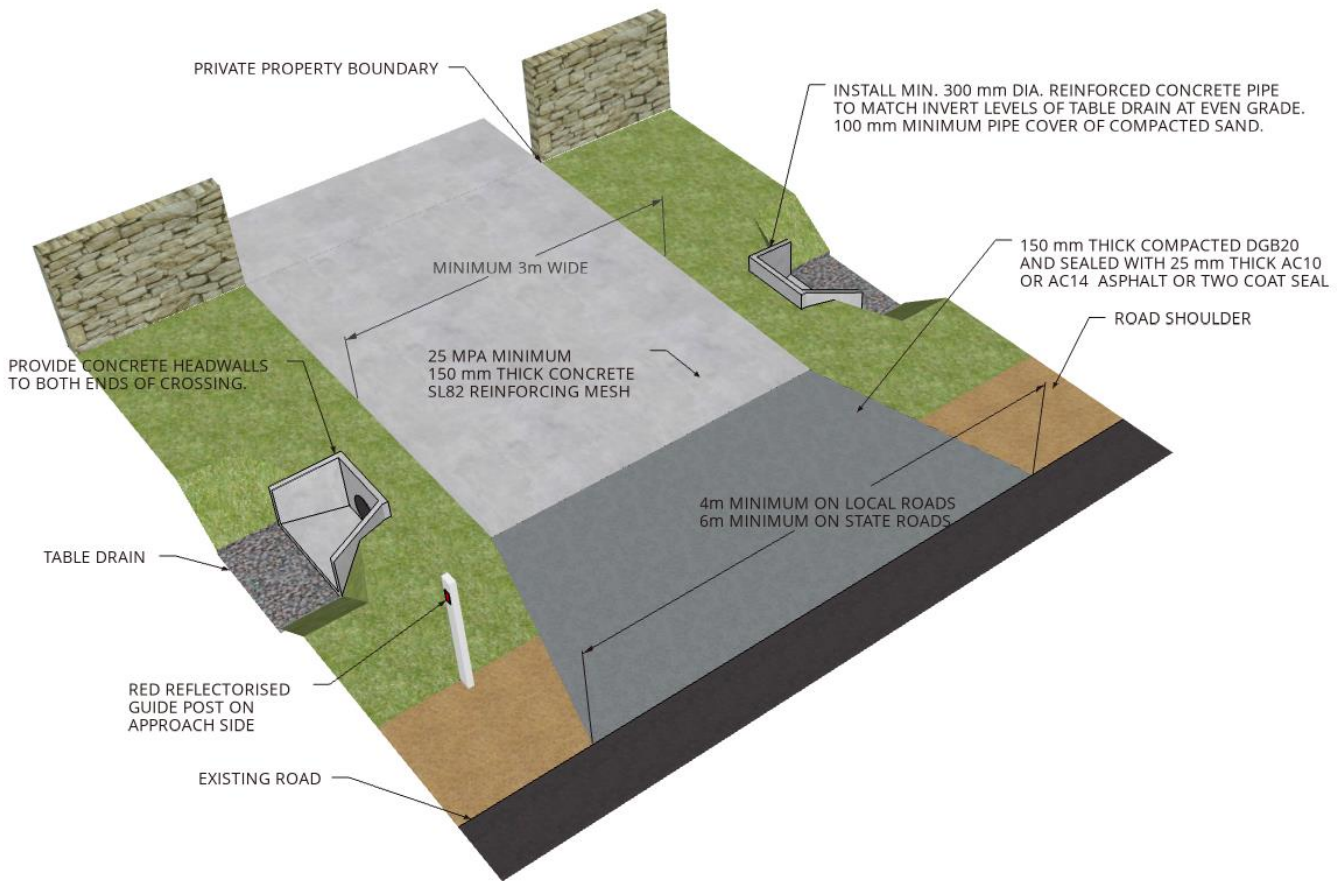

# 4 ROAD RESERVE RESTORATION WORKS

## 4.1 Council Permits, Inspections & Approvals

### 4.1.1 Council Permits, Inspections & Approval

- Any works in the road reserve will require Council approval under Section 138 of the Roads Act 1993.
- Where a private entity has opted to take responsibility for the full restoration of damage to Council's concrete assets on the road reserve, **an initial inspection shall be booked prior to concrete pour** by contacting Council's Asset Management Department via phone on (02) 4732 7777 at the latest **before 12PM one business day prior** to the requested inspection date. Sufficient time shall be allowed between the inspection and the pour for any required rectifications.

### 4.1.2 Public Domain Manuals

- Restorations shall make considerations for any overriding Public Domain Manual at the subject site.
- Current Public Domain Manuals are available on [Council's website](#).

### 4.1.3 Paver Materials

- Council shall be contacted for direction and required specifications of pavers prior to commencement.
- The manufacturer's specification and a sample of the paving material shall be submitted to Council for review and endorsement if the exact material cannot be sourced.

## 4.2 Concrete Asset Restoration

- This section shall deal with the replacement of concrete road reserve assets on the road reserve such as footpaths, kerb ramps, and kerb & gutters.

### 4.2.1 General Requirements

- Restoration of concrete assets shall be required for the full concrete panel(s), from control joint to control joint, where damage or defect is evident.
- Restorations shall match the existing alignment and shall be aligned in straight lines and in smooth circular curves.
- Subgrade shall be completely free of depressions, potholes and loose materials, trimmed and compacted in readiness for construction.
- Backfill finish shall be done with premium weed free topsoil and shall be lightly compacted, or wheel rolled after formwork has been stripped, turfed and shall be flush with the adjoining structure.
- Restorations works shall match existing works in compliance with this specification or better.

## 4.3 Pedestrian Access

### 4.3.1 Footpaths & Shared Cycleways

- Below are the requirements for footpath and shared cycleway restorations.

	Typical Footpath	Shared Cycleway
<b>Footpath Base</b>	30mm compacted sand or granular base on compacted subgrade	
<b>Concrete Thickness</b>	100mm thick	125mm thick
<b>Footpath Width</b>	Match existing	Match existing
<b>Concrete Strength</b>	25MPa plain grey concrete	
<b>Crossfall</b>	Footpath 2% generally, Nature strip 4% where possible	
<b>Concrete Finish</b>	Non-slip broom finish perpendicular to the direction of travel	
<b>Reinforcing Bars</b>	SL72 mesh centrally placed on chairs	
<b>Dowels at Expansion Joints &amp; Tie-in Points</b>	3 x 12mm galvanized dowels evenly spaced	12mm galvanized dowels at 300mm each side, 900mm centres
<b>Expansion &amp; Dummy Joints</b>	Full depth expansion joints every 6m and dummy joints every 2m in between	Full depth expansion joints every 6m and dummy joints every 3m in between

- If an existing pit is lower than the proposed footpath level, the pit shall be raised to footpath level or the footpath tie-in point to be taken a few panels back either direction to the point where the footpath gradient is sufficient to slope towards the pit.
- Additional 12mm trimmer bars shall be installed around the corners of pits where applicable.
- Longitudinal edging is required on footpaths. All expansion joints shall also be edged.

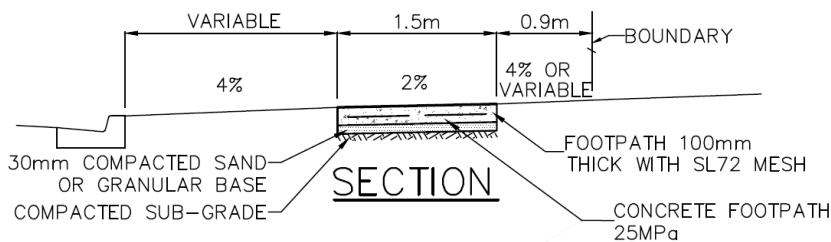

#### 4.3.2 Kerb Ramps / Pram Ramps

- Refer to Council Drawing SD1002 for typical kerb ramp details.
- Kerb ramp shall align with opposite kerb ramp where applicable.
- 30mm compacted sand or granular base on compacted subgrade.
- Minimum 25MPa concrete 150mm thick with SL72 mesh centrally placed on chairs with 40mm top cover.
- Maximum sloping grade shall be 12.5% (1 in 8).
- Tooled or mastic joints at sharp transitions and at back of kerb line.
- 12mm galvanized dowels shall be provided at 300mm from edge then at 600mm centres at the back of kerb and footpath.
- Kerb ramp shall have flat plane panels.

### 4.4 Kerb & Gutters

#### 4.4.1 Kerb & Gutter Reconstruction

	Typical Kerb & Gutter	Rolled Kerbs
<b>Sub-base</b>	Min. 175mm thick and shall extend 300mm beyond the back of the kerb. Material shall be a DGS classified material or equivalent	
<b>Dowels and Spacing</b>	2 x 12mm galvanized dowels evenly spaced at expansion joints & tie-in points	
<b>Joints</b>	Dummy joints every 3m	
<b>Concrete Strength</b>	25MPa plain grey concrete	
<b>Pavement Restoration</b>	Min. 150mm thick basecourse and shall extend 300mm beyond the lip of the gutter. Material shall be a DGB20 classified material or equivalent. Install 50mm thick hotmix asphalt and crack sealed.	

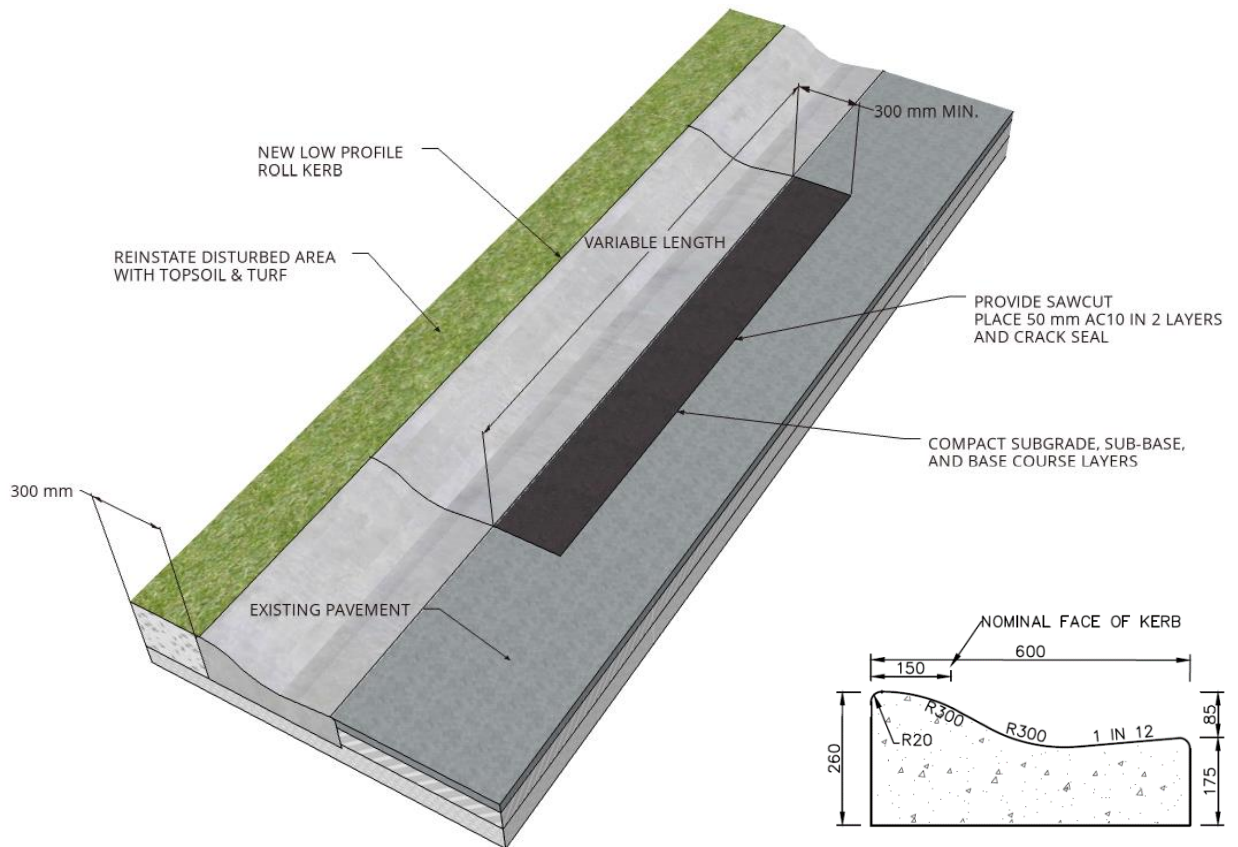
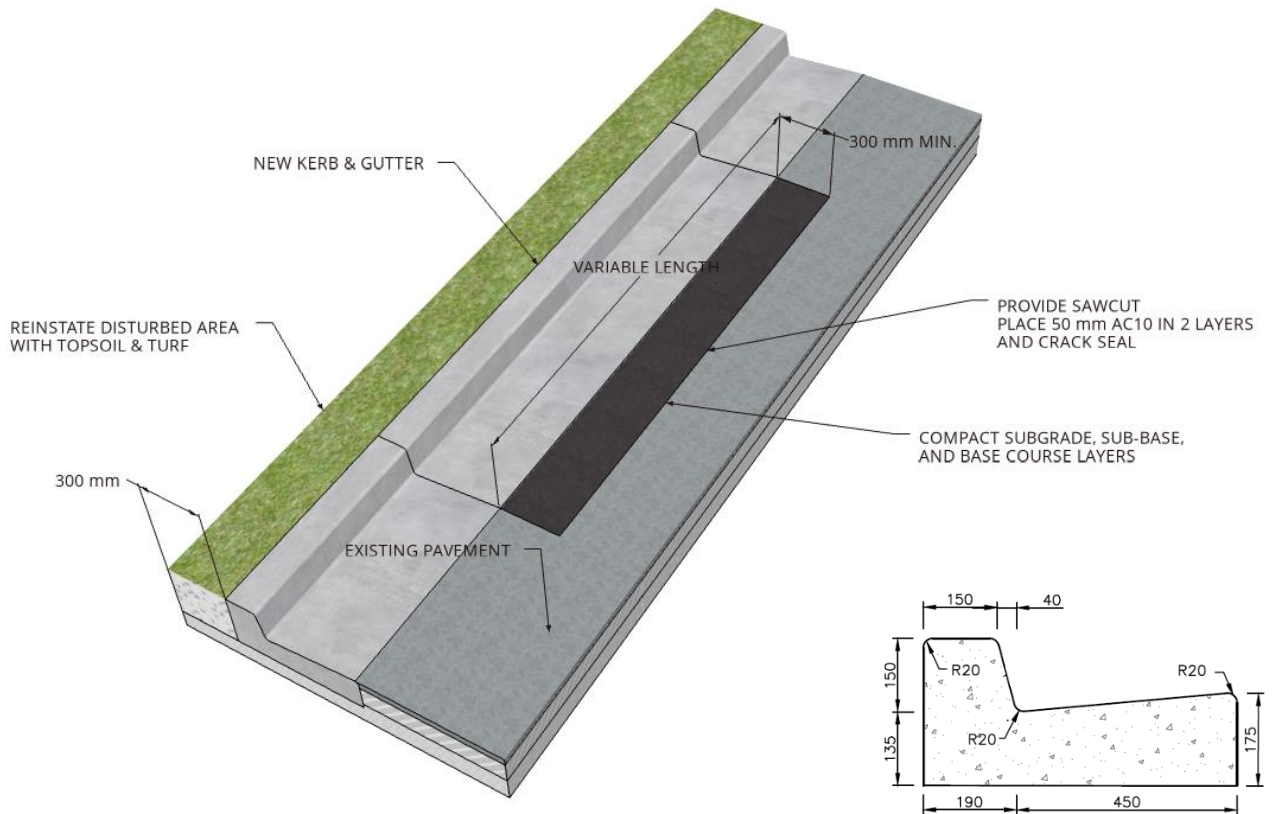

#### 4.4.2 Private Stormwater Outlets

- Stormwater pipes crossing the road reserve shall have sufficient cover as to not affect any footpath panels and shall be either 90mm PVC-U sewer grade pipe or 100x50 galvanized RHS steel channel.
- Stormwater outlets for residential properties with a typical kerb & gutter profile (excluding rolled kerb) shall be installed with a galvanized full kerb-height adaptor. See below example images



- Multiple full kerb height adaptors shall be 50-100mm apart.
- Private stormwater outlets shall not be situated within the layback and wings. For outlets on rolled kerbs minimum 300mm from edge of driveway.
- Where a panel has been cut and partially restored to allow installation of a private stormwater line, the full footpath panel shall be fully restored.
- A galvanized steel RHS channel can be accepted for use as an outlet in rolled kerb profiles provided that the channel is cut flush at the kerb face.

#### 4.4.3 RHS Stormwater Outlets

- A galvanized steel RHS channel can be accepted for use as an outlet in kerb & gutter profiles where greater flow capacity is required in lieu of the full-kerb height adaptor (or as indicated in a DA approved plan) provided the following is adhered to:
  - Kerb sawcut 100mm either side of the channel
  - N10 bars or reinforcing steel mesh is installed on top of the RHS with 30mm top cover
  - 12mm dowel into existing kerb
  - Angle shall be no less than 45° to the kerb line in the direction of flow in the gutter

#### 4.4.4 Redundant Stormwater Outlets

- Full panel kerb & gutter shall be restored when stormwater outlet has been made redundant.

### 4.5 Road Pavement

#### 4.5.1 General Restoration

- The existing pavement shall be sawcut 300mm beyond the furthest point of damage/defect.
- Pavement restorations shall be crack sealed where applicable.
- Linemarking and any raised pavement markers removed as part of the works shall be reinstated.
- Construction of new roads and road infrastructure shall refer to Council's Engineering Construction Specifications.

#### 4.5.2 Service Utility Trenching Road Pavement Restoration

- Backfill shall be 14:1 stabilised sand/cement mix.
- Base shall be minimum 150mm non-recycled virgin DGB20 or equivalent compacted in 50mm layers.
- Pavement sawcut joints shall be crack sealed.
- Wearing course surface is to be sealed as per below for different road types:
  - **Local Roads** – 2 x 50mm AC10 or AC14 layers on top of properly compacted base layer
  - **Local Roads Roundabout Intersection** – 2 x 50mm AC14 layer polymer-modified on 2 x 100mm deep lift AC28 material on top of properly compacted base layer
  - **Industrial Roads** – 2 x 50mm AC14 layer on top of properly compacted base layer
  - **Industrial Road Roundabout Intersections or Cul-De-Sacs** – 2 x 50mm AC14 layer SBS polymer modified on 2 x 100mm deep lift AC28 material on top of properly compacted base layer

#### **4.5.3 Service Utility Trenching on Nature Strip**

- Utility trenching works that affect driveways, footpaths, kerb & gutters shall be full panel restorations from one construction joint to the next available construction joint.
- Additional joints shall be avoided.

#### **4.6 Decorative Thresholds**

- Restorations on decorative/traffic thresholds shall need the review and approval of Council's Assets department.

#### **4.7 Nature Strip**

- Upon completion of all works in the road reserve, all disturbed verge areas and verge areas fronting the development are to be topsoiled and turfed (or at least grass seeded).
- The nature strip shall be grassed from the back of kerb to the property boundary, with the exception of concrete accessways, service pits, and other infrastructure which is not to be turfed over.
- Turf / topsoil installed shall finish flush to all edges.

## 5 GLOSSARY OF TERMS

Terms	Definition / Explanation
AC	Asphaltic Concrete
AS	Australian Standards published by the Standards Association of Australia and being current at the time of application.
Base Layer	Layer of aggregate material that lies below the pavement and usually consists of crushed aggregate.
Compaction	The process whereby the density of soil is increased by mechanical means. This typically involves, rolling, impact or vibration, or a combination of these processes.
Concrete	A thoroughly mixed combination of cement, aggregates and water, with or without the addition of chemical admixtures or other materials, all of which separately and when combined conform to the requirements of this specification.
Control Joint	Refer to Movement Joint
Construction Joint	Refer to Movement Joint
Council	Penrith City Council as represented by its employees.
Cover	The distance between the outside of the reinforcement and the nearest permanent surface excluding any surface finishing material or protective coating.
DA	Abbreviation for Development Application
DCP	Abbreviation for Development Control Plan, which is a document that supplement the provisions of Local Environmental Plans with more detailed planning and design guidelines.
Driveway	A structure that allows vehicle to traverse from the garage of a private property up to the property boundary line where it meets the Driveway.
Dummy Joint	A groove cut into a concrete slab to form a line where the slab can crack with only minimum damage.
Expansion Joint	A full depth joint that is made between parts of a concrete structure for the specific purpose of permitting relative movement between the parts on either side of the joint. This is interchangeable with the terms Control Joint, Construction Joint, and Movement Joint.
Layback	An invert section of a Driveway with a flatter than normal profile to allow vehicles to easily traverse the kerb from the road onto the Driveway.
Road Reserve	Council owned land which can include a combination of assets such as footpaths, nature strips, and kerb & gutters, Driveways, and roadways.
Subgrade	Compacted layer of native soil
TfNSW	Transport for New South Wales, the Roads Authority for State Roads.
Topsoil	Topsoil is natural surface soil that may contain organic matter.